



## **ASSEMBLY INSTRUCTIONS DOMED STYLE 60x40x18 WITH SINGLE DOOR**

***Please read instructions completely before you begin. This will help attain the best results for your installation.***

### **CONGRATULATIONS!**

Congratulations on your purchase of a MDM Products 60x40x18 Round Style Portable Building. With proper installation, use and maintenance, your new unit will provide many years of good and suitable service. Your new MDM Products portable enclosure is a combination of excellent engineering and well thought out design. The unit is comprised of a rigid tubular frame, covered with a long life polyethylene cover and door ends.

The multiple part frame assembly is pre-drilled for easy insertion of frame bolts. The tubing is made from high-grade galvanized steel, resisting moisture and oxidation over the life of the shelter. The cover and doors are made from **ASTM-5** approved polyethylene materials. The cover is UV protected for exposure to sunlight.

### **SAFETY WARNING**

**The installation of this unit must conform to the requirements of all authorities having jurisdiction in your specific local area. In the absence of such requirements, the assembly and installation must conform to the provided assembly and installation instructions. MDM Products, LLC will not responsible for failure to comply with any requirements in a given local area. Damages, consequential damages, or injuries caused by improper installation, alteration, improper use, or damages caused by snow, wind, or any acts of nature are strictly that of the user. Unit is not intended for occupancy for any length of time. NO running of internal combustion engines, open flames or contact with heated surfaces is allowed.**

For installation assistance or Customer Service, please call 800-447-7079 or 203-877-7070, 8AM-5PM EST. Cartons should be inspected upon delivery from carrier, and any evident damages should be noted on the bill of lading before signing. If upon opening the cartons hidden

damage is discovered, contact carrier or it's agent immediately. Claims for shipping damage **MUST** be made with the shipping company. An inspection of the goods will most likely be required. Do not discard packing or any components before the freight company inspection. All claims for freight damage must be made within 15 days of receipt of the goods in accordance with ICC regulations.

### **ASSEMBLY PROCEDURE**

The proper sequence and steps to install this unit will produce a proper and good installation. Failure to read and follow these guidelines may result in an improper installation and will void all warranty and protection the owner is entitled to with the product. The overall steps to be undertaken are:

1. Perform an inventory check before beginning, to be certain all components are available for installation.
2. Prepare location and place all unit boxes near location sight.
3. Assemble Seven (7) Arch Assemblies of unit.
4. Secure Base Flanges to Base Surface.
5. Begin Frame Assembly with Front End Arch, first Interior Arch, and Wind Braces with the first ridge crest, and side rail sections.
6. Add additional Interior Arch Assemblies with each section of side rails.
7. Add Rear Arch and Rear Wind Braces. Plumb Frame of Unit.
8. Install Rear Panel and Front Panel Framing.
9. Install Main Cover over frame assembly.
10. Install Rear Fabric Cover over Back Panel.
11. Install Front Fabric Panels over Front Panel.
12. Install Mechanical Roll Up Door

### **TOOLS REQUIRED**

The following hand tools will be needed for proper installation of your new MDM Products building:

- 12mm, 14mm, and 17mm Open End Wrenches
- 12mm, 14mm, 17mm Sockets or Box Wrench
- Large Flat Head Screwdriver 2lb maul or Sledgehammer
- 4 Foot Level
- 14' Step Ladder
- Stakes & String for aligning Base Plates & Frame

### **INVENTORY CHECK**

Start installation procedure by removing all components from packaging to ensure all components are present. Inventory chart appears on the last page of this manual.

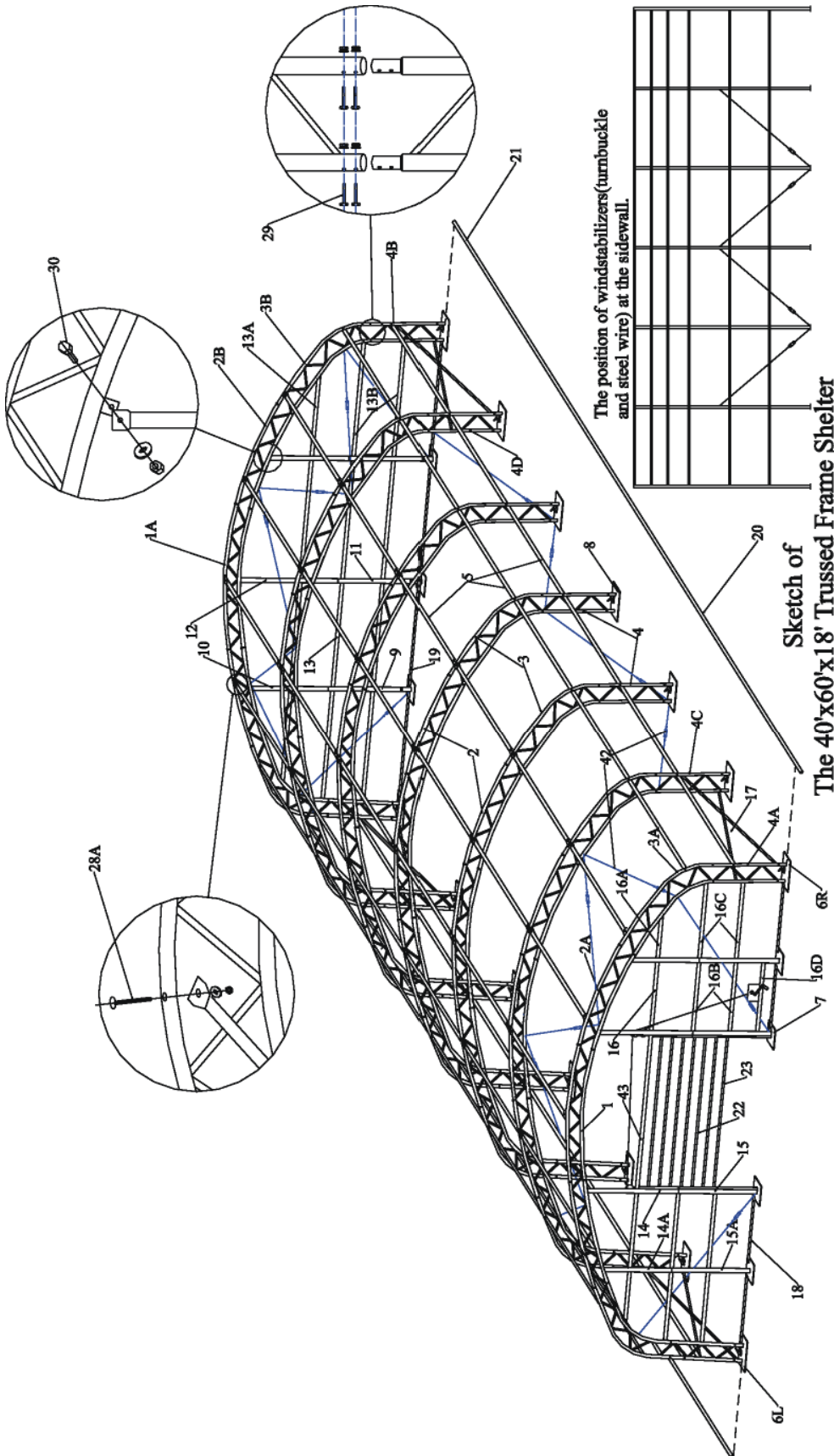

### SITE SELECTION & PREPARATION

Select a level or as close to level as possible location for your MDM Products Building. As the components fit into each other as a level unit, there can be no more than 1.5 inches difference between one base flange and another. Time spent preparing the base will pay off in years of good operation without binding of parts and doors.

The only suitable location is on top of a poured concrete pad.

The unit should not be located under trees, which will shed hard fruit such as apples, walnuts, or heavy pine cones. The cover of your unit will protect against normal falling leaves and light debris, however, large branches or other falling items may cause a puncture or tear in the cover material.

Take notice of drainage around your intended location. Water draining from the surrounding terrain should be planned so that it does not run into the unit. As well, rain or melting snow that comes off the unit should be drained away rather than accumulate and pool around the unit.

Check to be certain that adequate clearance is allowed for entry and exit.

When selecting a location for the building, consideration should be taken of the ability of the ground to keep the base flanges in place, as well as support the weight of the building and content. Using the stakes and string, measure off and square area for intended installation. Level the ground as best as possible. A properly leveled frame yields maximum strength.

### **ARCH ASSEMBLY**

#### **Step #1 – Assemble Arches**

Unit consists of One Front Arch, Five (5) Interior Arches, and One Rear Arch. Assemble each arch on ground. Begin by laying out the components of the Front Arch. Front Arch consists of:

- One (1) Top Ridge Tube (1)
- Two (2) Front Wall Curved Roof Tube (2A)
- Two (2) Front Wall Sidewall Tubes with Wind Brace supports (3A)

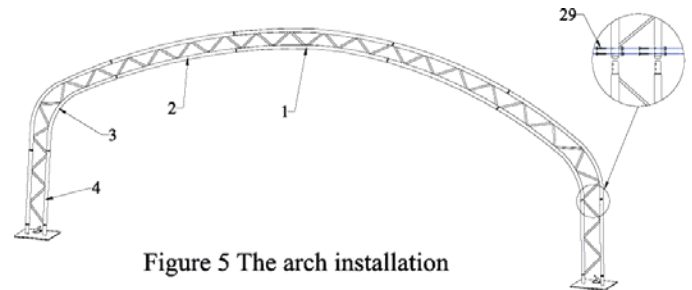

Figure 5 The arch installation

Components slide into each other at the ends. Sidewall tubes (3A) must be faced so the clips for Wind Brace Supports are facing to the next interior arch. Secure them together using M10x85 Carriage Bolt, washer, and nuts. Only snug up nuts, do not over tighten nuts.

Use Carriage Bolts with Washers and Nuts through pre-drilled holes in frame members. Be certain to insert carriage bolts from the outside into the interior of the unit, with the washers and nuts on the inside of the frame. This will prevent the bolts from puncturing through the cover material. Do not tighten down the nuts completely until frame is fully assembled and set in place.

Assemble Rear Arch in same manner. Rear Arch consists of:

- One (1) Top Ridge Tube (1)
- Two (2) Rear Wall Curved Roof Tube (2B)
- Two (2) Rear Wall Sidewall Tubes with Wind Brace supports (3B)

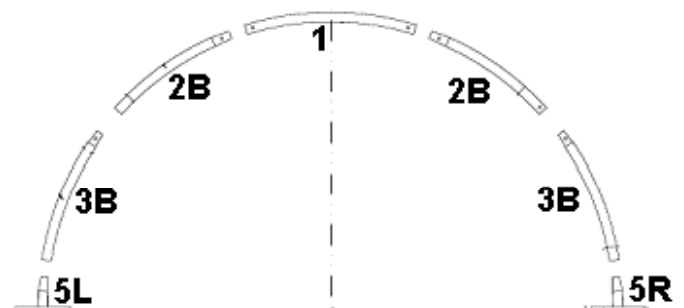

Assemble each of the five (5) Interior Arch Assemblies.

Refer to Figure 1 Frame Assembly to review Interior Arch #2 and #6 requirements (directly inside End arches). These arches must have the Sidewall Tubes (3C & 3D) that accommodate the Wind Brace Supports. The first Interior Arch from the Front Arch must use Sidewall Tube (3C), with clips for wind brace supports facing towards the end arch. Welded Wind Brace Tabs should be on the bottom of the sidewall tube.

Each Interior Arch #3, #4, and #5 consists of:

- One (1) Top Ridge Tube (1)
- Two (2) Curved Roof Tube (2)
- Two (2) Sidewall Tubes (3)

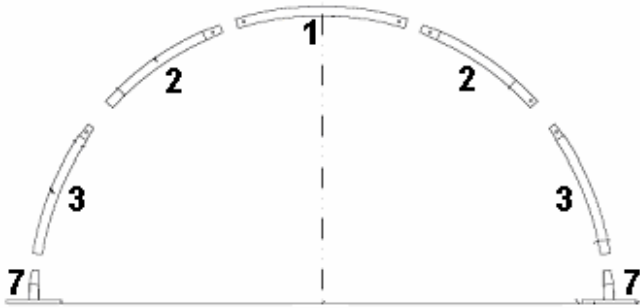

### SECURING BASE FLANGES

#### Step #2 – Secure Base Flanges in Position

In order to assemble arches into a frame assembly, the Base Flanges (5L, 5R, 6, & 7) must be secured to the mounting surface. Begin Refer to figure 2 (last page of manual) for an exact layout of all base flanges.

Begin by determining exact location of the four (4) corners of the building. Mark front edge and side-to-side width of assembly on ground. Drive alignment stakes into the ground outside of the markings, and draw alignment strings along both ends and sides of the building to the dimensions shown in Figure 2. The outline of the strings will represent the final location of the base flanges. The initial location of each Corner Base Flanges (5R & 5L) is critical to the alignment and fit of the frame components and cover. Locate the Left Corner Base Flange (5L) and Right Corner Base Flange (5R) for the front corners of the building. Secure the base flanges with either or both the Auger style anchor (20) or the earth anchor (21). Measurements shown in Figure 2 are to the center of the upright sockets on each Base Flange.

Layout and secure all Base Plates as shown in Figure 2.

Note that Sidewall Base Plates (7) and Base Plates Front & Rear Standing Legs (6) are different and not interchangeable. Sidewall Base Plates are used only along each side of assembly. Standing Leg Base Plates are positioned along the Front and Rear Arches to secure vertical beams in each.

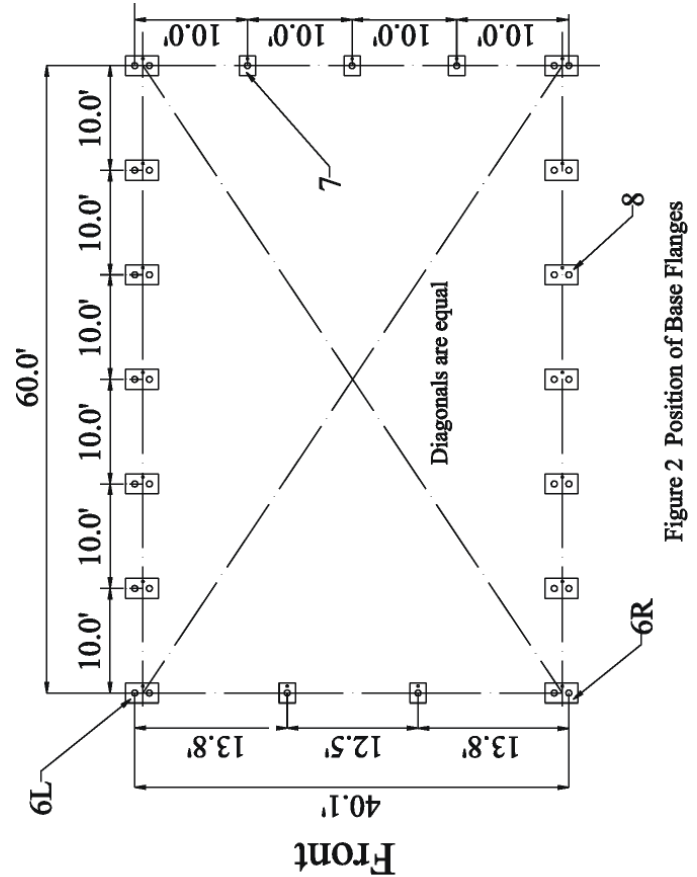

Figure 2 Position of Base Flanges

The 60x40x18 building must be secured to a firm surface that can receive and retain anchors firmly in position. Both Auger Style and Earth Style anchors are included within this assembly kit. If securing to the ground or to blocks that might shift later, it is recommended that both style of anchors be used to avoid base flanges moving during or after assembly. If securing to a concrete pad, blocks, or other hard surfaces, anchors must be field supplied. Regardless of base material, the Base Flanges must be secured so they cannot be moved. Arches are tensioned at their base as they insert into the base flange sockets.



Installation of Earth Augers

Using one base flange as a panel, mark the Earth Auger hole through the base flange by pushing the Auger point through the base flange hole in place. This will leave an impression in the ground when the base flange is removed. The auger tip should be started into the ground where the depression under the hole was made.

After the hole is marked, move the base flange to one side to expose the impression for the Auger. Using the specially designed wrench (40), turn the earth auger into ground. Leave sufficient shaft above the ground to allow for the base flange thickness and adequate thread to be exposed for the washer and nut to be tightened over the base flange.

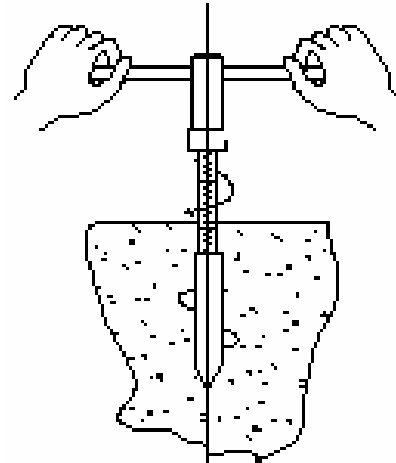

Replace the base flange into place, with the threaded shaft of the auger sticking through the base hole. Re-check the dimension from the corner or adjacent base flange before tightening. Tighten the nut and your assembly will be securely fastened to the ground.

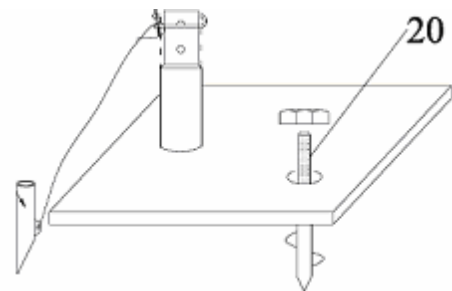

Follow the above procedures for each subsequent Base Flanges of the assembly. It is suggested that you begin with the four corner anchors to be used as reference points to the next base flange. Alignment and dimensions should be checked continually as Base Flanges are secured.

### Installations of Earth Style Anchors

Each MDM Products 60x40x18 building comes with 18 EARTH CABLE ANCHORS (21) with U-bolts and nuts (22). These versatile anchors allow the frame to be secured to almost any surface. In addition you have also been provided with a 36" Drive Rod (23) used to drive the anchor heads into the earth.

If the location where you are placing the building has very hard ground or any rock in it, pre-drill the holes before inserting anchors. Hammer drills can be rented at most home improvement or rent-all centers. Hitting the anchors into rock will cause the drive rod end to mushroom inside the anchor head, and prevent the drive rod from coming out of the hole.

Anchor placement should be made inside the frame. Anchors secure the building to the ground to prevent spread of the frame over time.

Step 1. Place the drive rod provided into the cup of the anchor. Using a heavy hammer drive the anchor into the soil until 6-8 inches of cable remains above the earth. Remove drive rod.

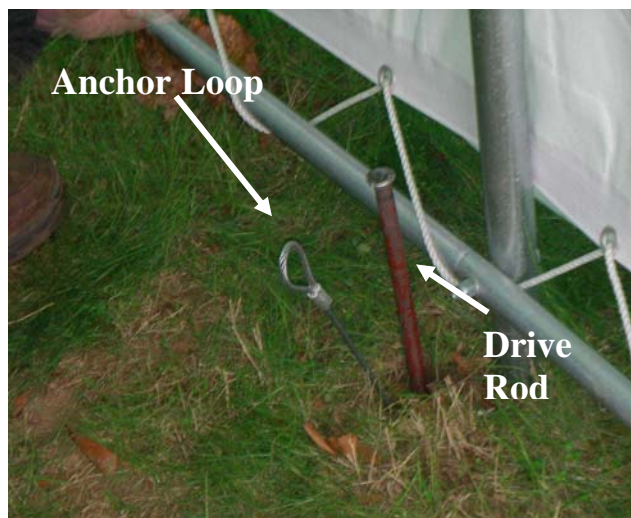

### **EARTH ANCHOR STEP 2**

Place the Drive Rod through the loop in the anchor lanyard. Pull upward to set anchor head into the ground.



washers and nuts on the inside of the frame. Do not tighten down the nuts completely.

## **ERECTING ARCHES**

### **Step #4 – Combining Arches Into Frame**

Begin frame assembly by erecting Front Arch into Front Corner Base Flanges. Place left frame sidewall tubing into the upright tube socket into the Left Base flange. Place Carriage Bolt (24A) through base flange socket and arch sidewall tube hole.



### **EARTH ANCHOR STEP 1**

### **EARTH ANCHOR STEP 3**

Slip one side of the U-bolt (22) through the eyelet at the end of the anchor cable. Attach the cable to the base flange socket with the U-bolt and tighten. Ensure there is no slack in the cable. Slack can be removed by wrapping the cable around the base flange upright socket.

Use Carriage Bolts with Washers and Nuts through pre-drilled holes in frame members. Refer to detail drawing for correct hardware. Be certain to insert carriage bolts from the outside into the interior of the unit, with the

Secure the Cross Rail tubes (4) into place using carriage bolts (24A) and nuts.

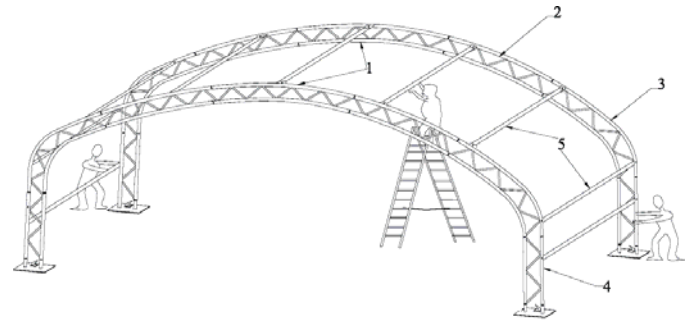
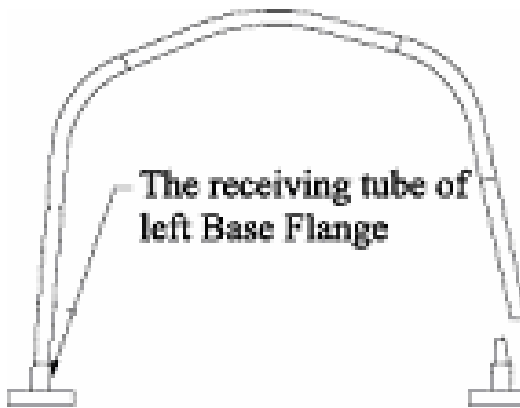

Figure 6 Hint of Installation of arches

Note: Cross Rails (Purlin Horizontal Tubes) (4) are secured inside the arch assemblies.

Use Carriage Bolts with Washers and Nuts through pre-drilled holes in frame members. Refer to detail drawing for correct hardware. Be certain to insert carriage bolts from the outside into the interior of the unit, with the washers and nuts on the inside of the frame. Do not tighten down the nuts completely.

Next install the Wind Brace supports that connect the Front Arch to the first Interior Arch (#2). Use two Wind Brace Supports (14) in an 'X' fashion between the sidewall tubes. Use a Wind Brace Clip (14A) at the end of each Wind Brace support tube. The Wind Braces give the arch assemblies strength as a unit.

In order to insert Right Sidewall Tube into Right Front Corner Flange, it is necessary to support arch on left side to prevent movement. Position Right Sidewall Tube over Right Corner Base Flange. It will be necessary to push arch assembly inward to fit into Right Base Flange Upright Socket. This tension is normal, and will help rigidity of completed frame assembly.

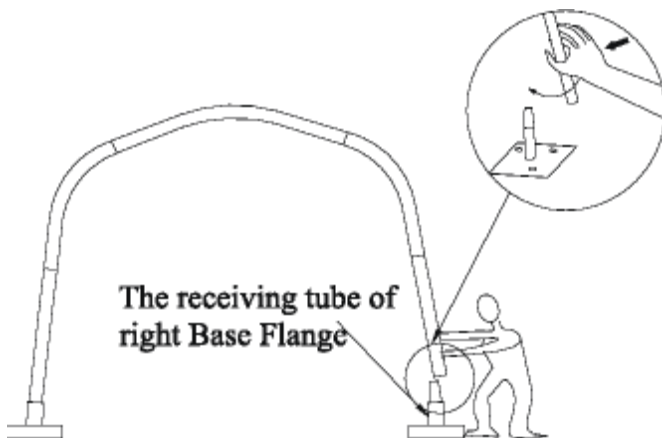

Once right sidewall tube is placed into right corner base flange, insert a carriage bolt and nut to prevent it from popping out of the socket while assembly continues.

Next stand first interior arch up to repeat insertion into Base Flanges. Place left sidewall tube into the upright socket of first interior Base Flange. Put carriage bolt through base flange and sidewall tube to secure in place.

Supporting the left side of arch, pressure arch assembly inward to put right sidewall tube into right side Base flange upright socket.

Immediately after putting first interior arch into place, connect Front Arch and Interior arch using Cross Rail Tubes (4) at top ridge and side shoulder cures of arches.

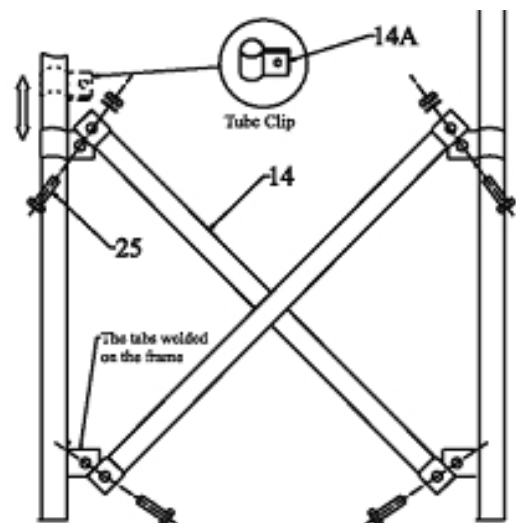

Use Bolt M10X30 (25) at the end of each Wind Brace Support to secure. Check level of arch upright before final tightening of Wind Brace Clip (14A). Slide clips as needed on Arch Sidewall until Arch is level and plumb.

Continue to install Interior Arch Assemblies #2, #3, and #4, in the same manner. Overlap pinched ends of Purlin Horizontal Cross rails onto same carriage bolts inside frame assembly.

Install Interior Arch #5 (next to Rear Arch), with the Wind Brace Support Tabs on the Sidewall Tube (3D) facing the Rear End Arch. Install Rear End Arch into Base Flange Sockets. Install final Cross Rails (Purlin Horizontal Tubes) and Wind Cross Brace Assemblies as described above. Check end Arch for plumb before securing the Wind Brace bolts tight.

Next check entire frame assembly for square and plumb. Adjust Wind Braces and Cross Rails (Purlin Horizontal Tubes) as necessary to bring frame into plumb. Next tighten frame bolts adequately. Do NOT over tighten bolts so as to oval or compress frame components.

## ERECTING FRONT WALL SUPPORTS

### Step #5 – Assemble Front Wall Framing

Assemble Side Beam for Front Panel from Upper Door Track (10) and Lower Door Track (11). Support Door Track with Upper Beam of Front Panel (12) at junction point. Lower Door Track goes into Base Flange (6) at the base. Upper door track (10) secures to Curved Roof Tube (2A) at top with M10X30 Bolts. Repeat this assembly procedure for both left and right side of Front Panel for Door. Do not fully tighten bolts and nuts until all framing is in place and plumb.

Assemble Door Beam (39) across Upper Door Tracks (10). Use M10x75 Bolts and Nuts. Next assemble Lower Beam of Front Panel (12A) on right side of assembly. This beam will support door roll up assembly.

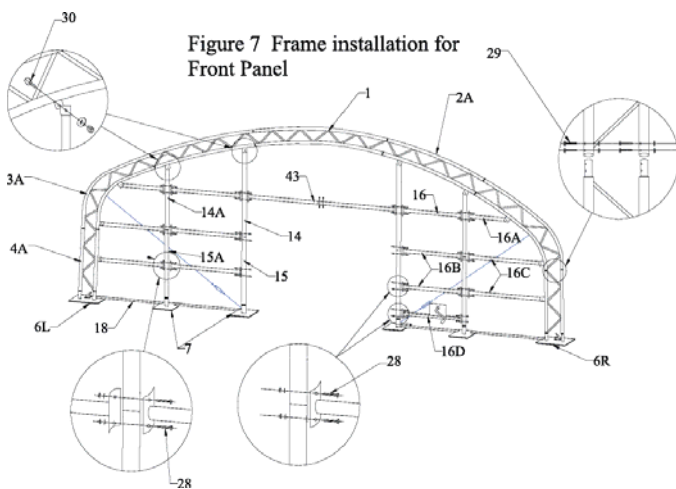

Once all frame members are in place, use a level to check for plumb and square. Adjust as needed. After all is plumb, tighten nuts and bolts adequately. Do not over tighten hardware to compress or oval frame members.

## ERECTING REAR WALL SUPPORTS

### Step #6 – Assemble Rear Wall Framing

Assemble Vertical Upper Standing Legs (9) to each side of rear arch assembly. Legs go into Base Plate (6) at base, and attach to Rear Arch Curve Tube (2B) at the top. Side Beam (9) secures to Curved Roof Tube (2B) at top with M10X30 Bolts. Position and secure Back Panel Middle Beam (13A) horizontally between two Upright Beams (9). Next assemble Horizontal Side Beam for Back Panel (13) on each left and right side of Rear Arch assembly. Secure Side Beams (13) for Back Panel across rear arch with M10x30 Bolts and nuts.

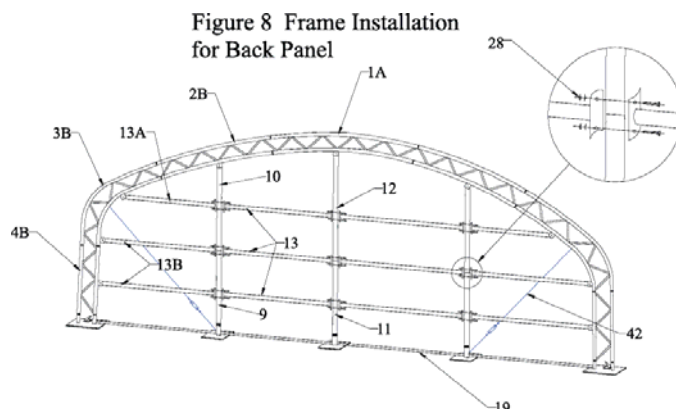

Once all frame members are in place, use a level to check for plumb and square. Adjust as needed. After all is plumb, tighten nuts and bolts adequately. Do not over tighten hardware to compress or oval frame members.

## MOUNT TIE DOWN RATCHETS TO BASE PLATES

### Step #7 – Bolt Ratchets to Base Flanges

Attach Tie Down Ratchet Assemblies to each Base Flange along Sidewall. Use two Bolts M10x15 for each sidewall ratchet to secure to Base.

## MAIN COVER INSTALLATION

### Step #8 – Prepare Frame and Position Main Cover

To elongate the life of Main Cover, put a small square of duct tape (field supplied) over each bolt head on frame that comes in contact with cover. The tape acts as a



cushion to avoid rubbing damage to the cover over years. As an alternative, foam rubber pipe insulation makes a good cushion between the bolt heads and the main cover as well.

When ready to install Main Cover (30), unpack cover and lay parallel to building frame on one side. Cover

must be pulled over top of frame assembly without being snagged or stressed on any frame members. Use multiple ropes over top of frame as shown in picture below. Having another person inside frame on a ladder to assist in getting Main Cover (30) over frame will insure cover will go on without any damage.

### Figure 12 Method of Roof Cover Installation

As figure 12 shows, please pull the roof cover over the frame evenly.

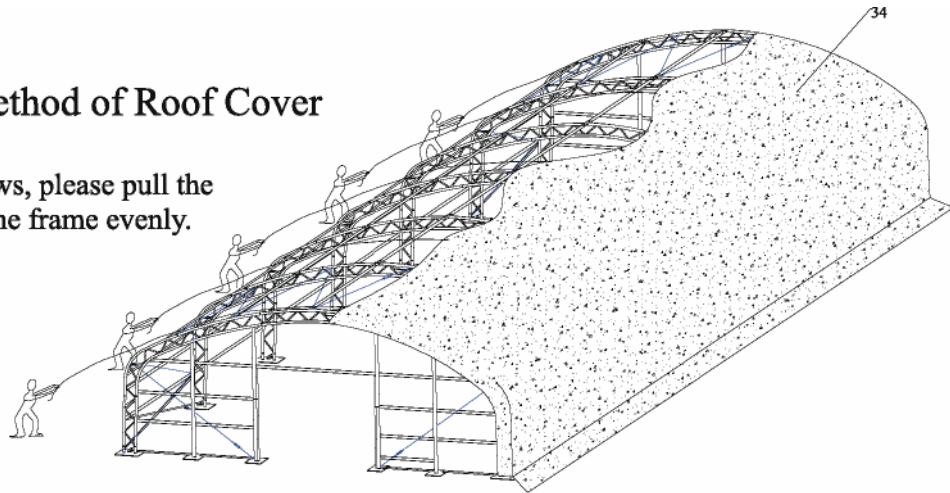

Figure 12

### Step #9 – Tension Cover On Frame Side-To-Side

Center Main Cover over Frame assembly both side to side and front to back. Next insert Tensioning Tube Plastic Caps (37) into the ends of the Tensioning Tubes (17) as shown in Figure 13. Insert the Tensioning Tubes into the pockets in inside edge of Main Cover on each side. Align one side of Main Cover evenly front to back. Put Band for Tie Down Ratchets (36) over Tensioning Tubes at each Base Flange along one side. Bands do not attach to Tensioning Tubes, but loop around and secure at both ends on ratchet.



Next take up slack in tie bands by ratcheting the mechanisms tightening cover. Evenly adjust ratchets on both sides of main cover to take wrinkles out of main cover. Do NOT fully tighten cover yet. Leave adequate slack so that cover can also be adjusted front to back in next step.

### Figure 13 Fastening the roof cover

Please insert the Tensioning Tube for lower roof cover(part code 20) into the "sleeves" of the bottom of both sides of roof cover. In the meantime please put the Band for tie down ratchet(part code 32A) onto the tubes and pull the Bands through the reels of the Tie down ratchet(part code 32). Ratchet down until cover is fully tensioned.

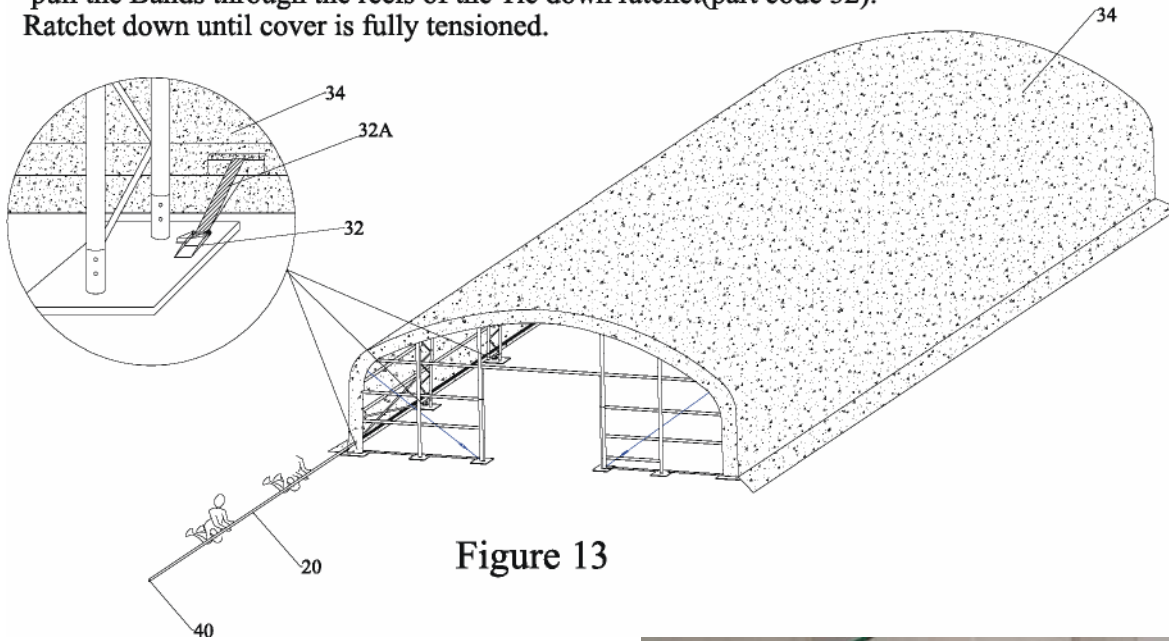

**Figure 13**

### Step #10 – Tighten Main Cover on Frame Front To Back

The main cover is tensioned from front to back by the rope lacing to grommet flaps inside the main cover, inside the unit at front and rear arches. Using the rope (34) provided, lace the main cover grommet flap around the main frame front and rear arch pieces. Start in the top middle of each arch, and lace to each side. Add rope length by tying pieces together or cutting as necessary.



Begin with the front arch at the top. Pull the rope through the middle grommet until both ends of the rope meet. Loosely lace the rope down each side, without pulling the rope taut yet. Then lace the rear grommet flap to the rear arch frame the same way. Tie off one end to the lower frame member. Now go back to the top again, and start taking the slack out of the rope evenly

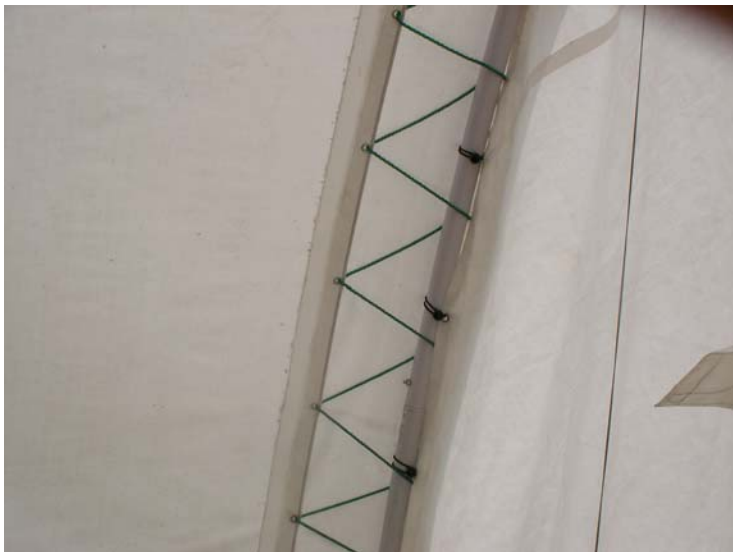

**Rear Panel Cover** - With the Main Cover on the frame and secured, next is to mount the fabric panels on the front and rear panel walls. Start with the Rear Panel Cover (33). The panel secures to the rear panel frame along the perimeter of the arch with the Elastic Bungee Cords (35) provided. The Bungee cords (35) should be put on from the inside, so that the ball of the cord ends up inside the frame, not between the frame member and cover. Each grommet on the panel, as well as the horizontal grommet flaps on the panel, should have a Bungee cord installed. Start at the side and work towards the top and other side, to avoid putting the weight of the panel on the beginning bungee cords. Once all bungee cords are on, it may be necessary to re-adjust the panel so that it is centered on the frame. At the base of the Rear Panel Cover (33), insert the Rear Panel Tensioning Tubes (15A) into the three packets at the base edge of the Rear Panel Cover. Use a Fabric Band for Tie Down Ratchet ((36) to loop over the Tensioning Tubes and secure to the Ratchet Assemblies (27). Tighten the Ratchet Assemblies adequately to secure the Rear Panel (33), but do not over tighten to stretch panel.

along the edges. If necessary, loosen up on the tensioning pole ratchets so the cover can be adjusted front to back. Adjust both the front and rear lace rope so that there is an even amount of material both at the front arch and the rear arch. Pull only tight enough to get all excess material out of the main cover over the frame members. Do not pull so taut that the grommets stress the main cover flap.

After the main cover lacing is adjusted evenly across the grommet flap, go back and re-adjust the Tensioning Ratchets along the side edges of the Main Cover. At this point, the main cover can be pulled taut enough to take all excess material and wrinkles out of cover. It will be necessary to repeat this step 2-3 weeks after unit assembly is complete and main cover has a chance to stretch out over the frame completely.

## ASSEMBLE FRONT & REAR COVER ON ARCH PANEL FRAMES

### Step #11 – INSTALL FRONT AND REAR PANEL ARCH FABRIC

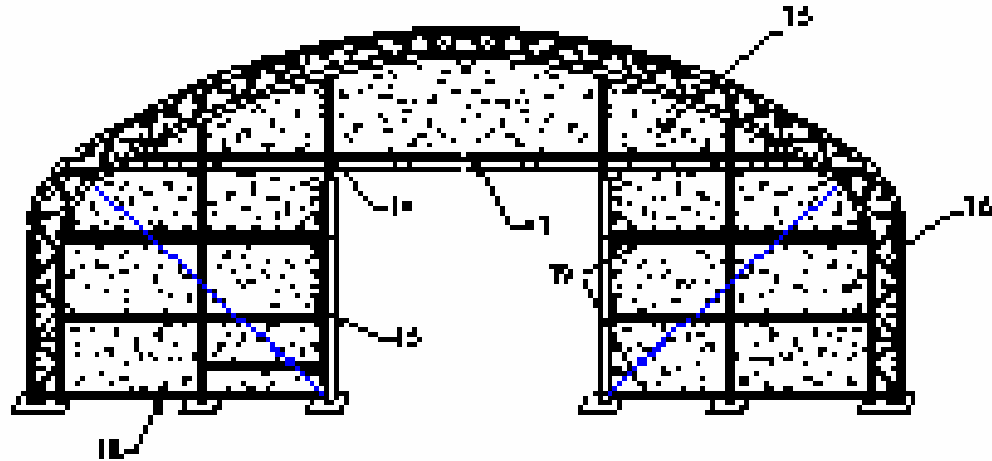

**Figure 15**

**Front Panel Covers** - The Fabric Covers for the Front Wall consist of three separate fabric pieces. Two Side Panels (31A) are installed on either side of the door frame opening. One of the panels has a cut out in it for the Winching Mechanism. This should be installed on the right hand side of the frame when facing from the outside.

grommet. Start securing the side covers at the bottom and work up towards the top. At the bottom of the panel, use one of the ropes provided to lace the fabric to the Lower Beam (15). A separate fabric cover, Cover above Front Door panel (31) is provided. Make certain to put Bungee cords (35) along the horizontal frame members as well as the perimeter of the panel.



These pieces secure to the Front Panel Frame with Bungee Cords (35) around the frame members at each

**Main Cover Edge Tie Off** - Once both Front and Rear Panel Covers are installed, the Main Cover Edge flap, front and rear, should be tightened and tied off. Begin by pulling the remaining Main Cover Material over the Frame arch, so the rope pocket is over the edge of the frame. Tie off the rope that goes through the rope pocket on one side. The rope ties off to the loop that is located on the Base Flange Corner (5L or 5R). Moving to the other side, begin to pull the rope down. Hold the rope in hand, and push down at the bottom of the rope with a foot. Pull the rope tight, and tie off to the welded hop on the Base Plate. As you are pulling the edge rope, it will be necessary to adjust the excess material that will collect along the rope packet. Adjust the material so that it is not bunched up and it does not pull the main cover to one side or the other. Once the Front is completed, repeat the process on the Rear flap of the Main Cover.

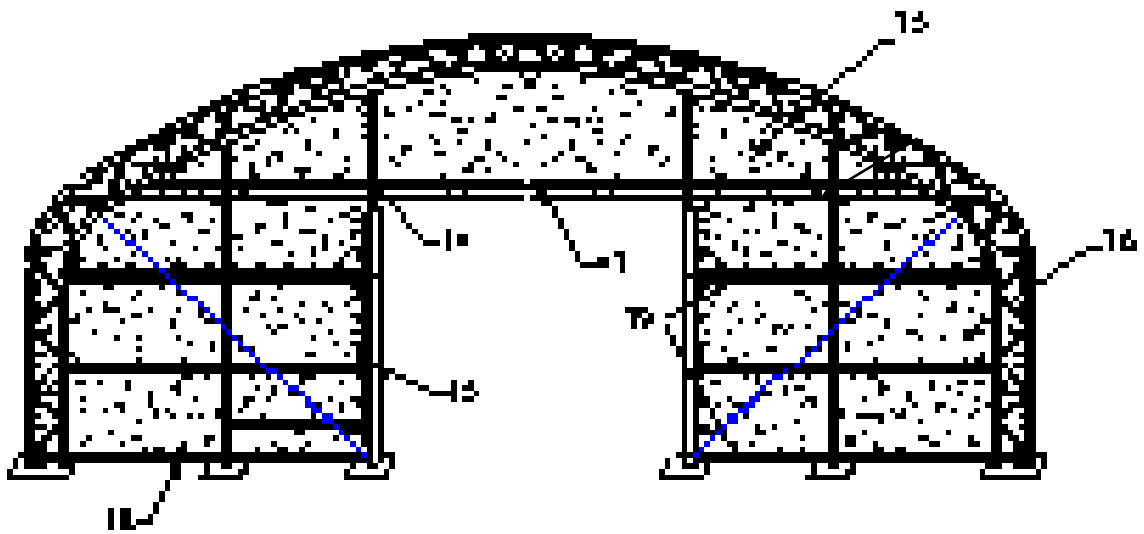
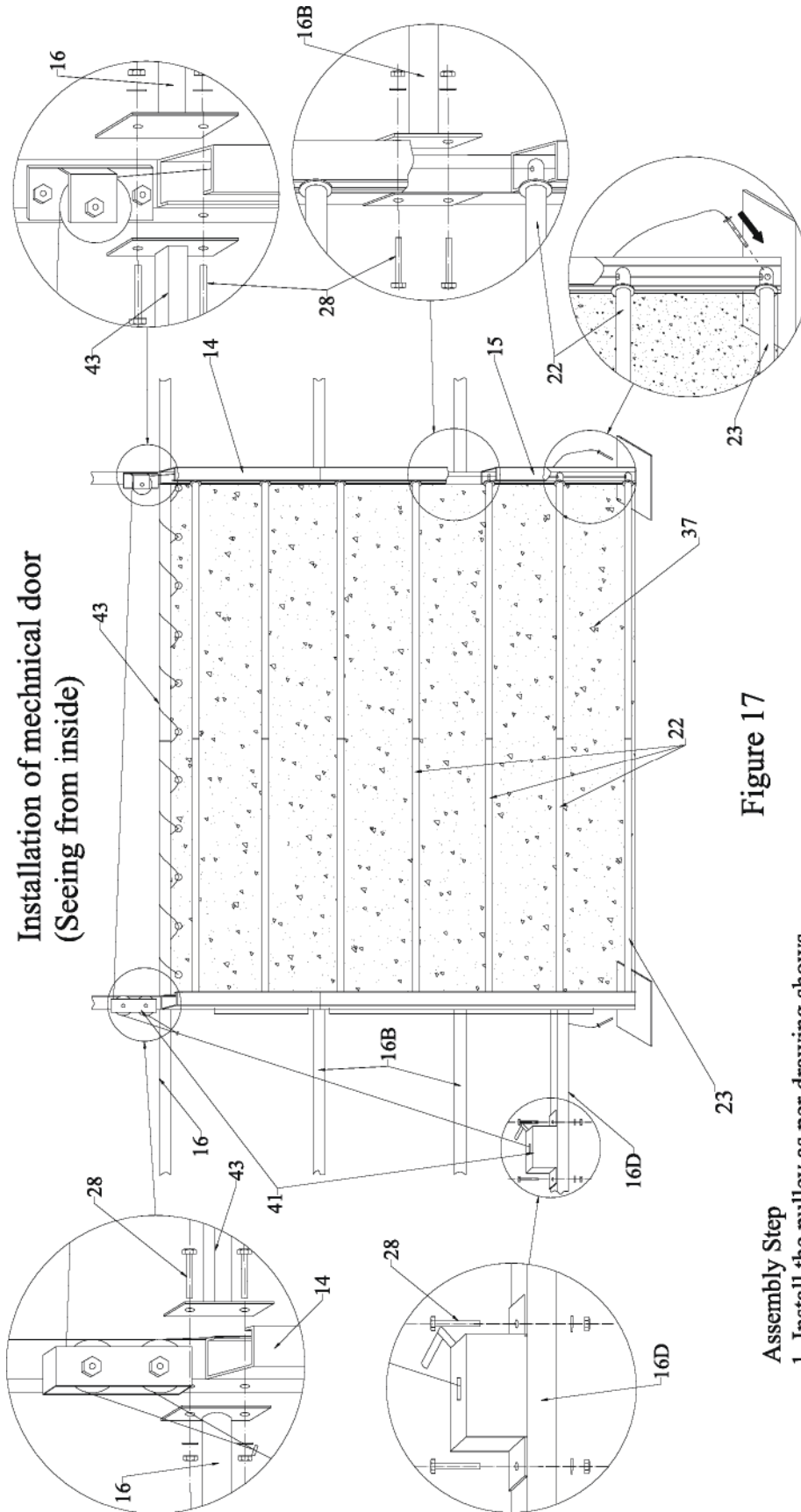

Figure 15

## ASSEMBLE MECHANICAL DOOR

Step #13 – Install Main Door, Cover, and Opener



**Installation of mechanical door  
(Seeing from inside)**

**Figure 17**

**Assembly Step**

1. Install the pulley as per drawing shows.
2. Each door dropping tube (part code #22 and 23) consists of two segments of tubes. Hang the door cover (part code #37) by rope, and put the door dropping tubes into the door sleeves.
3. Then put the two ends of door dropping tubes into the track of door frame.
4. Put the steel wire through the holes of door dropping tubes and pass the pulley to connect with the winch. Please note that the degree of tightness are adjustable. Then you can roll the winch by hand to lift up and down the door.

### Mechanical Door Installation Steps-

1. Install Main Door Pulleys (left and right) over the Top of the Door on each side of the Door Beam (39). Use M10x75 Bolts and Nuts (24A).
2. Next mount the Winch Mechanism to the Front Panel Lower Beam (12A). Mechanism should line up with pocket in Fabric Front Side Panel. Use M10x75 Bolts and Nuts (24A).



3. Use Elastic Bungee Connectors (35) to fasten the top edge of the Door Fabric Panel (32) to the Upper Door Beam (39).
4. Slide Bottom Door Dropping Tube (19) into the bottom horizontal fabric pocket on the Door Panel (32). Then slide the six remaining Door Dropping Tubes (16) into the remaining horizontal fabric pockets in the Door Cover (32)
5. Raise the Bottom Dropping Tube (19) to the top of the Upper Door Tracks (10). Put the Bottom Dropping Tube (19) into the tracks side to side so the ends start down the tracks. Gently allow the Door Cover to go down, and feed the six remaining Door Dropping Tubes (16) into the Door Tracks.



6. Next install the steel wire that leads from the bottom of the door dropping tubes to the door winching assembly. Take one of the Steel Wires in the Door kit, and feed down from the top of the Door track to the Bottom Door Tube Dropping Tube (19) on the right hand side of the door (facing from the inside). The steel wire should be threaded through the holes in the ends of the Middle Door Dropping Tubes (16) as it goes down. When the steel wire goes down though the hole in the Bottom Dropping Tube (19), tie a knot in the steel wire so that it cannot pass back up through the hole.
7. From the top of the Door Track, route the Steel Wire through the rollers of the Door Pulley at the top of the track. Then to the Door Pulley wheels on the left hand door track, and finally to the Winching Assembly on the Lower Font Beam (12A).





## **Maintenance and Care**

Annually or more often, the unit should be completely inspected internally and externally to make certain the unit remains properly installed and secured. Particular attention should be paid to:

Hardware – check all carriage bolts and hardware connectors to be certain they are in place and tightened.

Base Plate Anchors – during normal weather trends, the unit will strain against the base plate anchors under windy conditions. Anchor hardware connection to frame members should be maintained tight and depth of



anchors should be checked to be certain they remain deeply and firmly set.

Snow Accumulation – All snow accumulation on the main cover should be removed as soon as possible. Tap the main cover from the inside with a broom or soft brush to clear cover.

Main Cover Lacing – the poly rope that secures the main cover to the bottom rail of the frame assembly should be checked, and adjusted as needed. The tension on the main cover should be uniform from end to end and side to side. Rope ends must be tied off onto the frame members at the ends on each side.

Cleaning – cover and doors can be cleaned with a mixture of light detergent and water. A soft bristle brush with the mixture can be used to loosen any hard dirt, mold, or buildup on the cover. After cleansing, the cover should be rinsed thoroughly to avoid any chemical reaction from residual detergent. Allowing dirt and debris to sit on cover over an extended time will damage cover irreparably.

Severe Weather – in preparation for inclement weather, completely secure the door of your MDM Products portable building. Allowing wind to enter end lifts the building and puts undue stress on the anchoring system. This also shortens the life of the doors and main cover.

### Customer Service or Installation Assistance

Please call MDM Products at 800-447-7079 or 203-877-7070 for questions about the proper installation of the unit in any way. Care and attention to a proper installation will add many years of life and function to your MDM Products unit.

Please retain purchase documentation for your MDM Products unit. All warranty claims must include purchase documentation for verification. All parts on your MDM Products unit are available for replacement as needed. Protect your purchase by completing warranty registration card and mail/fax as soon as practical after installing your unit.

Thanks again for choosing this quality product. With proper operation and care we are confident it will meet your expectations in functionality, appearance and longevity.

## INVENTORY CHART

Part Code	Description	Quantity
1	Interior & End Arch Top Ridge Curve Tube	7
2	Interior Arch Curved Tube	10
2A	Front Arch Curved Tube	2
2B	Rear Arch Curved Tube	2
3	Sidewall Tube	6
3A	Front Arch Sidewall Tube	2
3B	Rear Arch Sidewall tube	2
3C	Sidewall Wind Brace Support	2
3D	Sidewall Wind Brace Support	2
4	Cross Rails (Roof Purlin & Horizontal Tube)	30
5L	Corner Base Flange – Left Side	2
5R	Corner Base Flange – Right Side	2
6	Base flange Standing Legs Front & Back Panel	4
7	Sidewall Base Flange	10
8	Back Panel Lower Standing Legs	2
9	Back Panel Upper Standing Legs	2
10	Upper Door Track	2
11	Lower Door Track	2
12	Front Wall Upper Beam	2
12A	Front Panel Lower Beam	1

13	Back Panel Side Beam	2
13A	Back Panel Middle Beam	1
14	Wind Brace Support	8
1414A	Wind Brace Tube Clip	8
15	Tensioning Tube – Front Wall Cover	2
15A	Tensioning Tube – Back Wall Cover	3
16	Door Tubes - Middle	6 Sets
17	Tensioning Tube – Main Cover	6 Sets
18	Tensioning Tube – Main Cover Ends	2 Sets
19	Door Base Tube	1 set
20	Auger Anchor	18
21	Earth Anchors w/SS Tether	18
22	U-Bolt, Retaining Plate, Nuts	18
23	36” Drive Rod for Earth Anchors	1
24	M10x85 Carriage Bolt	40
24A	M10x75 Bolt	75
24B	M10x85 Bolt	6
25	M10x30 Bolt	28
26	M10x15 Bolt for Tie Down Ratchet	28
27	Tie Down Ratchet	14
30	Main Cover	1
31	Fabric Cover Above Front Door	1
31A	Fabric Front Wall Side Cover	2
32	Fabric Door Cover	1
33	Fabric Back/Rear Panel Cover	1



34	Tie down rope for Main Cover, Front Wall Cover, Rear Wall Cover, and Door	9
35	Elastic Bungee Connectors	200
36	Fabric Band for Tie Down Ratchet	14
37	Tensioning Tube Plastic Cap	10
38	Mechanical Door Components	
39	Door Beam	1 Set
40	Earth Auger Wrench	1 Set